

Varenummer: 207321M101214ST
Beskrivelse: E+G Pasbolt
GN 732.1-M10-12-14-ST

Mål

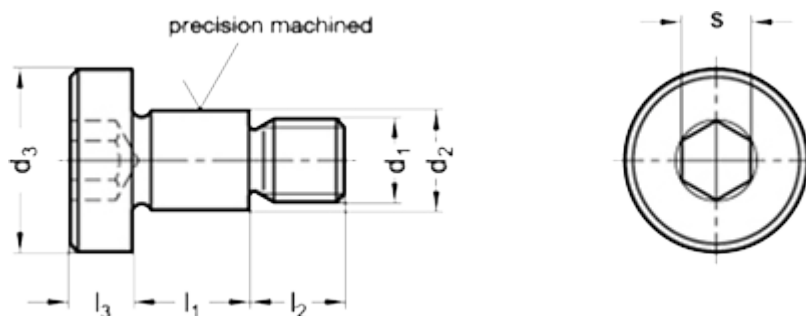

Application example



d1	= M 10
d2	= 12 -0.05/-0.08
d3	= 19
$l_1 +0.20/+0.13$	= 14
l_2	= 13
l_3	= 6
s	= 6
Vægt i (g)	= 19